



## NP12-12 NP12-12FR

Sealed Rechargeable  
Lead-Acid Battery

### 12V, 12.0Ah

### Specifications

- **NOMINAL VOLTAGE:** 12V
- **NOMINAL CAPACITY:**
  - 20 hr. rate of 0.6A to 10.5V 12.0Ah
  - 10 hr. rate of 1.1A to 10.5V 11.0Ah
  - 5 hr. rate of 2.1A to 10.2V 10.5Ah
  - 1 hr. rate of 7.2A to 9.60V 7.2Ah
- **WEIGHT (approx.):** 8.82 pounds (4 kgs.)
- **ENERGY DENSITY (20 hr. rate):** 1.70 WH/cubic inch (103.5 WH/liter)
- **SPECIFIC ENERGY (20 hr. rate):** 16.3 WH/pound (36.0 WH/kg)
- **INTERNAL RESISTANCE OF CHARGED BATTERY:** 16 milliohms (approx.)
- **MAXIMUM DISCHARGE CURRENT WITH STANDARD TERMINALS:** 40 amperes
- **MAXIMUM SHORT-DURATION DISCHARGE CURRENT:** 360 amperes
- **OPERATING TEMPERATURE RANGE:**
  - CHARGE 5°F to 122°F (-15°C to 50°C)
  - DISCHARGE -4°F to 140°F (-20°C to 60°C)
- **CHARGE RETENTION (shelf life) at 68°F (20°C):**
  - 1 month 97%
  - 3 months 91%
  - 6 months 85%
- **LIFE EXPECTANCY:**
  - STANDBY USE 3 to 5 years
  - CYCLE USE (approx.):
    - 100% depth of discharge 250 cycles
    - 50% depth of discharge 550 cycles
    - 30% depth of discharge 1200 cycles
- **SEALED CONSTRUCTION:** Can be operated in any position without leakage.
- **STANDARD TERMINAL:** Quick Disconnect .250
- **HOUSING MATERIAL:** ABS Resin
- **OPTIONAL:** Container and cover made from Flame Retardant ABS (UL94-V0/L.O.I.>28%)

### Terminal

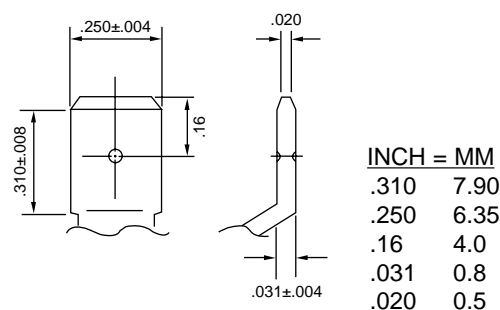

### Dimensions

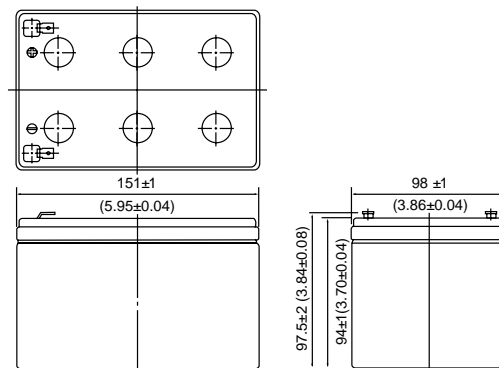

DIMENSIONS: MM (INCHES)

RECOGNIZED BY UL, File No. MH 16464



### DISCHARGE CHARACTERISTIC CURVES AT 25°C (77°F)

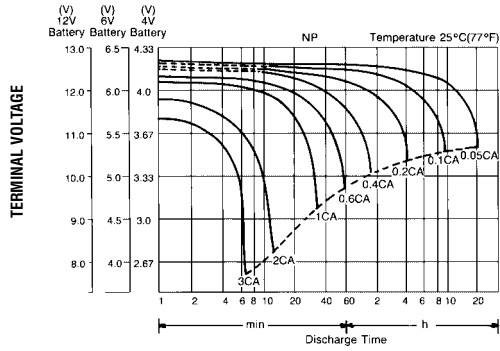

### TEMPERATURE EFFECTS IN RELATION TO BATTERY CAPACITY

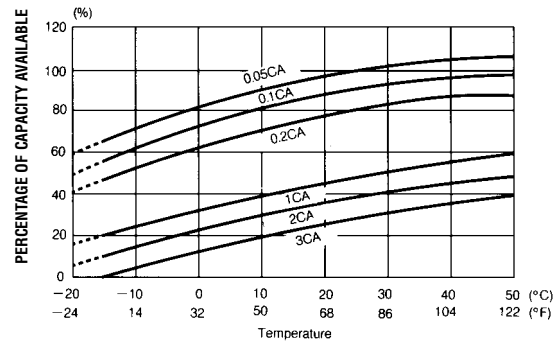

### SELF DISCHARGE CHARACTERISTICS

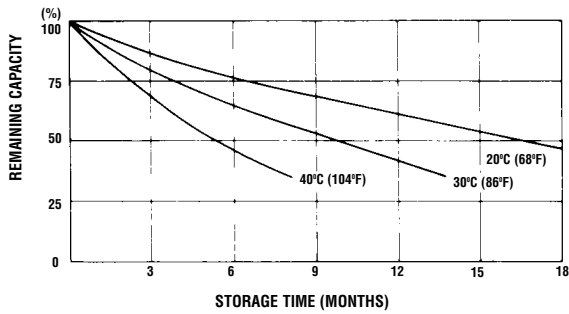

### OPEN CIRCUIT VOLTAGE VS REMAINING CAPACITY

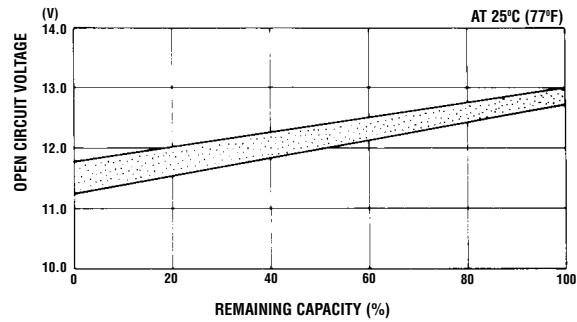

### CYCLE SERVICE LIFE IN RELATION TO DEPTH OF DISCHARGE

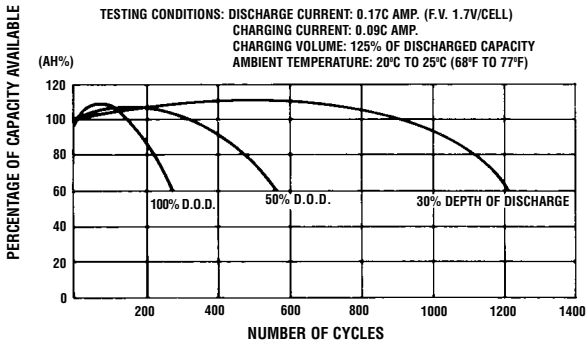

### FLOAT SERVICE LIFE

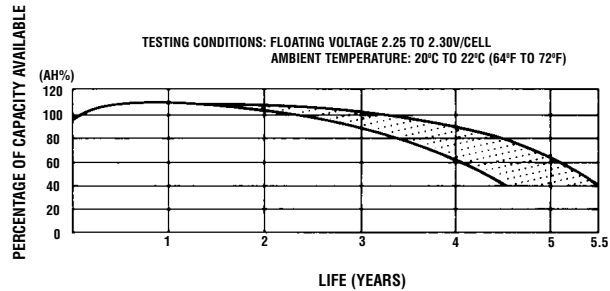

When the battery will be used by current in excess of 3C, consult with EnerSys, Inc. prior to use.

#### CHARGING METHODS (At 20°C)

**Cycle use:** Maximum charging current 3.0A  
 Charging voltage 14.4 to 15.0V  
**Standby use:** Float charging voltage 13.50 to 13.80V

- CAUTION**
- Avoid short circuit
  - Do not charge in a sealed container.



**EnerSys Inc.**  
 P.O. Box 14145  
 Reading, PA 19612-4145  
 USA  
 Tel: +1-610-208-1991  
 +1-800-538-3627

**EnerSys EMEA**  
 Brussels, Belgium  
 Tel: +32 (0)2 247 94 47  
**EnerSys Asia**  
 Guangdong, China  
 Tel: +86 755 2689 3639

Represented by: